

REQUIRED CONTAMINATION CLASS	ISO 4406 class 20/18/15
OPERATING TEMPERATURE RANGE	-20° to +90°C

INLET	DIRECTION
A	RIGHT
B	LEFT

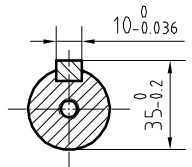
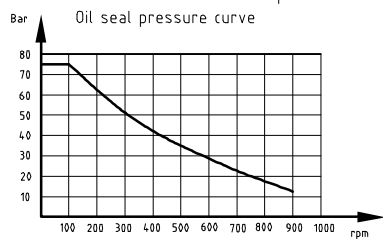
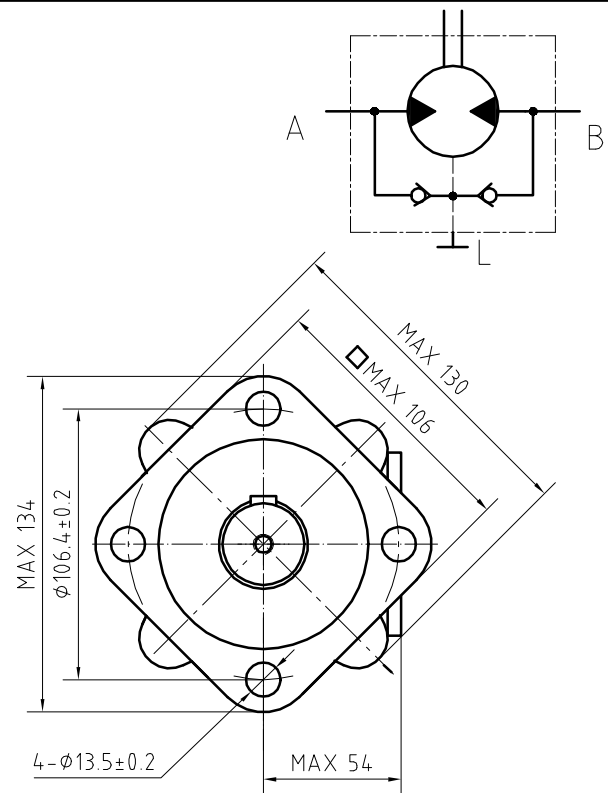
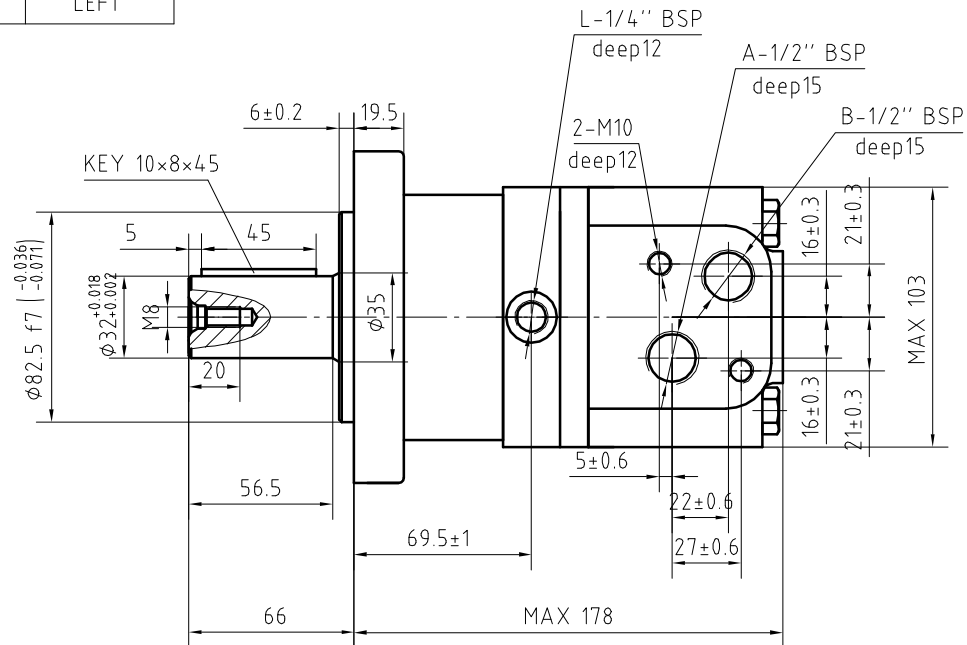

forward products

CE

TYPE _____

S/N: _____

PRESSURE(bar)		
CONTINUOUS	INTERMITTENT	PEAK
200	225	250
Type:Geroller		

Max allowed back-pressure or drain pressure: 25bar
 Max allowed torque: 345Nm
 Max speed: 590rpm
 PAINTING COLOUR: BLACK
 PAINTING THICKNESS RANGE: 0.04mm-0.06mm
 SHAFT: MAGNESIUM PHOSPHATED

forward products	Date 08.03.2019
Nom.Displacement 125cc/rmp	
FP-MS125-4H-CY32-01	